

Steel backing pre-drilled
for optional housing
anti-rotation pin

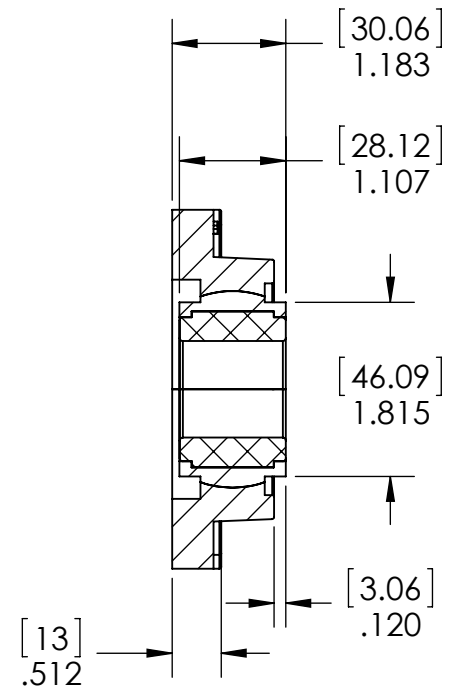
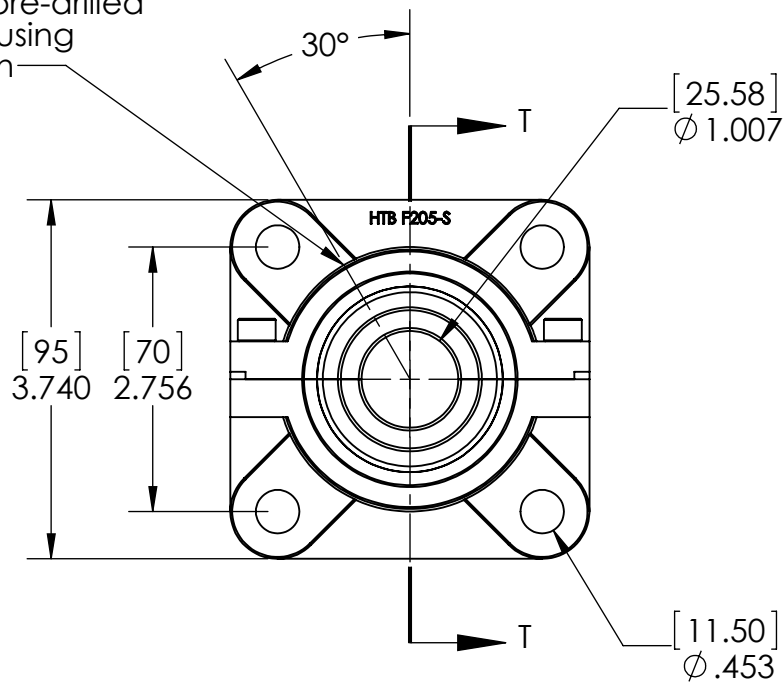

SECTION T-T
SCALE 1 : 2

Notes:

1: When ordering specify sleeve type by adding the suffix HT750, HT100 or NT600 (eg: 4BF205SHT750-100P) .

HT750: Carbon Grade rated to 750 F
HT100: Carbon Grade rated to 1000F
NT600: Polymer Composite Grade rated to 600F

2: 2-3 degrees of self alignment

High Temp Bearings

TITLE:

HT Split 4 Bolt Flange
Steel Backed Bearing

SIZE

A

DWG. NO.

4BF205SHTxxx-100P

REV

A

SCALE: 1:2

SHEET 1 OF 1